

FLAVOR SEPARATION USING W PRODUCTION

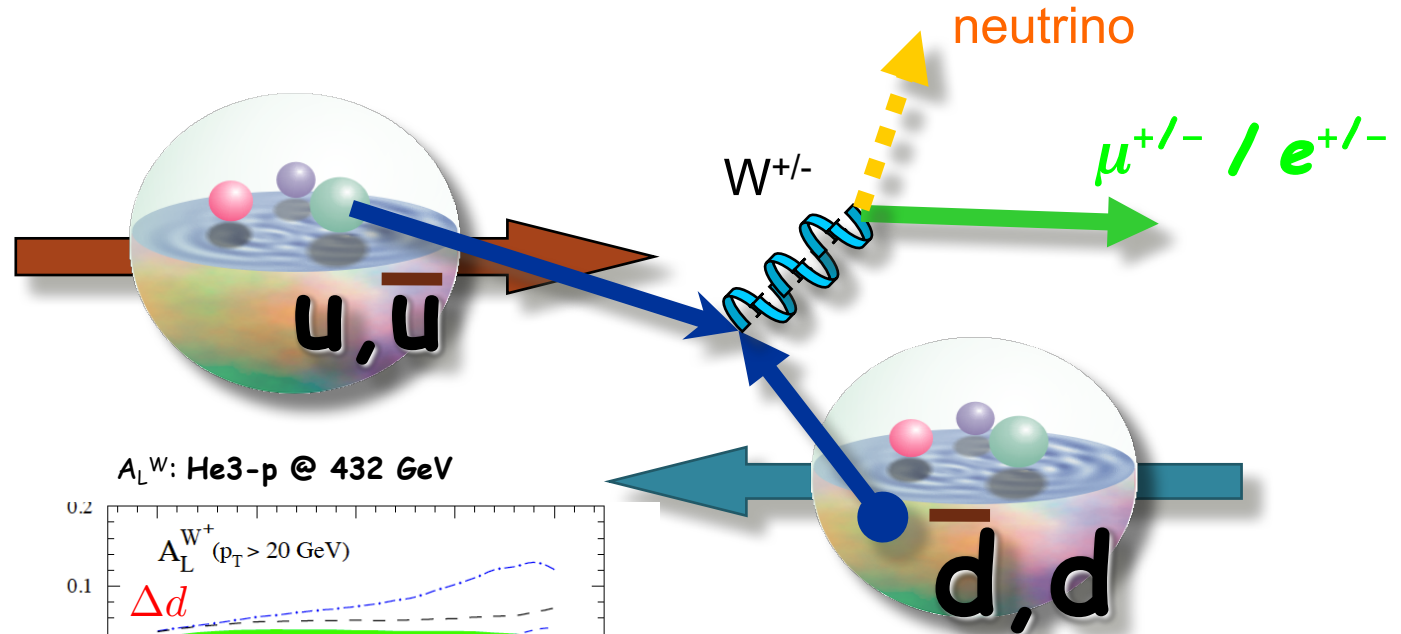

A_L^W : pp @ 500 GeV

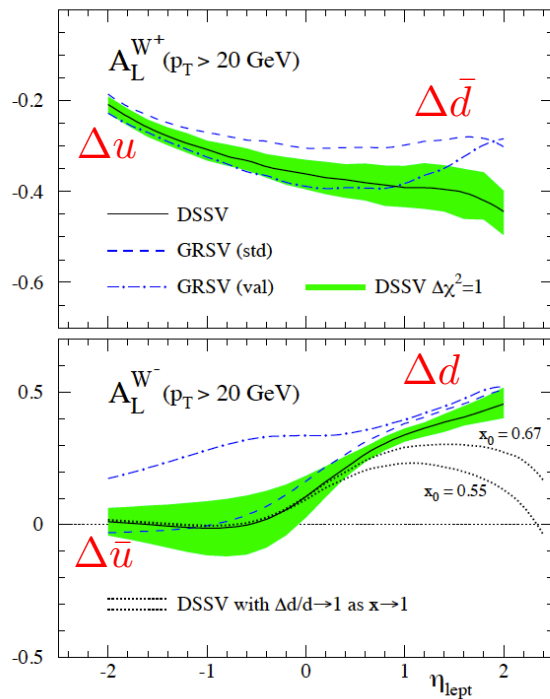

A_L^W : He3-p @ 432 GeV

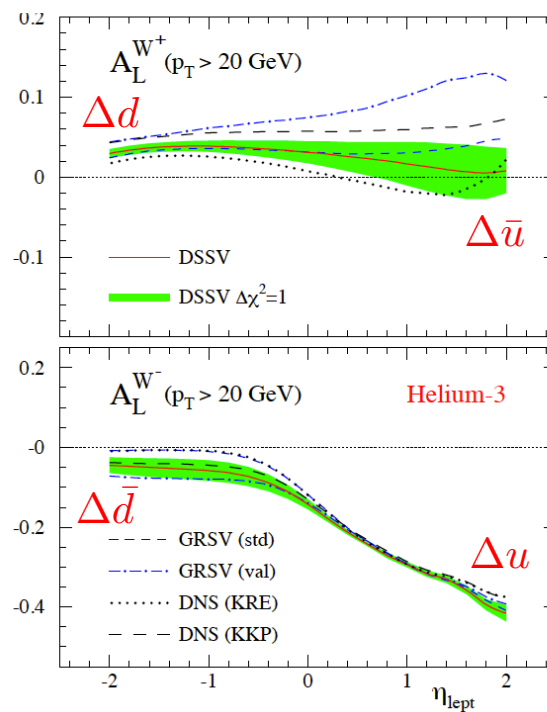

Since W production is maximally parity violating \rightarrow W 's couple only to one parton helicity large Δu and Δd result in large asymmetries.

RECENT RESULTS FROM RHIC

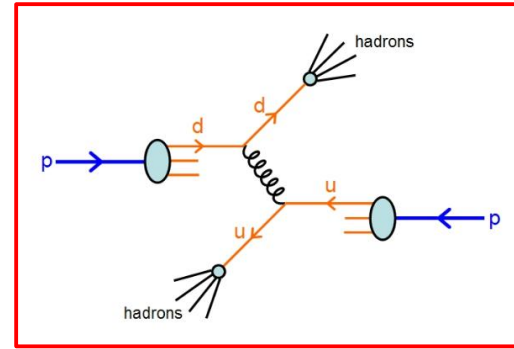
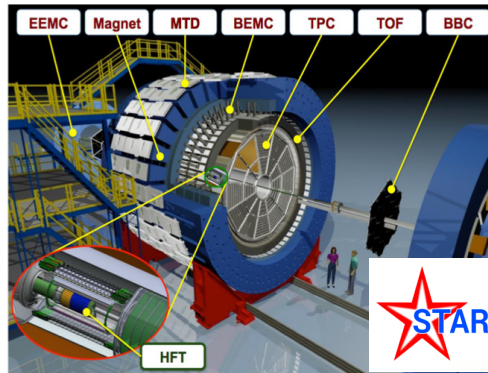
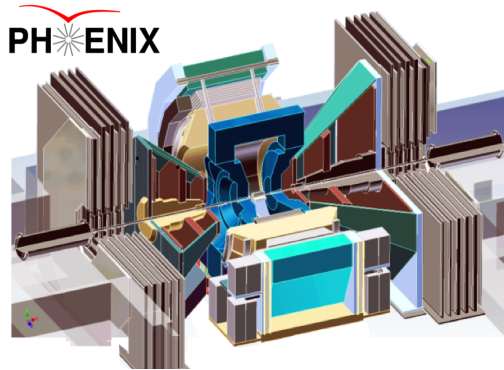

$$\sigma \sim f(x_1) \otimes f(x_2) \hat{\sigma}^{x_1+x_2 \rightarrow h_1+h_2+X}$$

STAR: PRL 115, 092002 (2015)

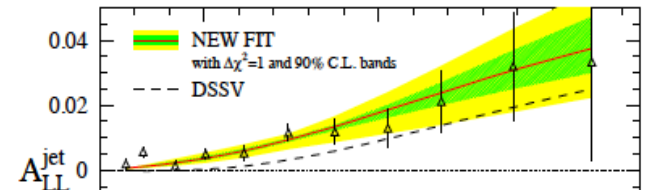

Jet

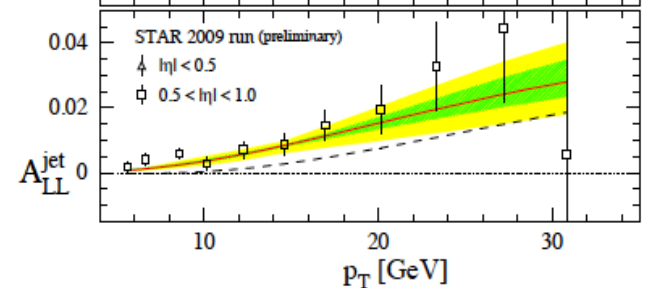

PHENIX: PRD 90, 012007 (2014)

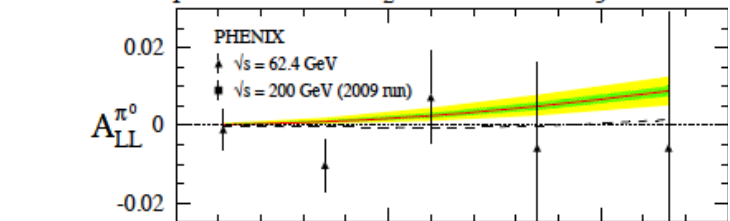

pi0

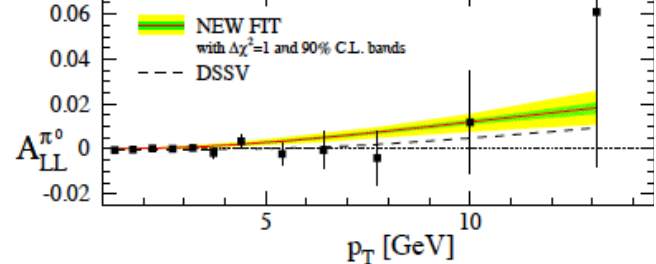

$$\int_{0.05}^1 \Delta g(x, Q^2) dx = 0.2^{+0.06}_{-0.07}$$

"RHIC Cold QCD Plan for 2017-2023", arXiv:1602.03922

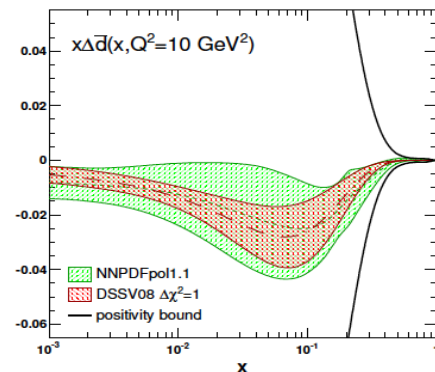
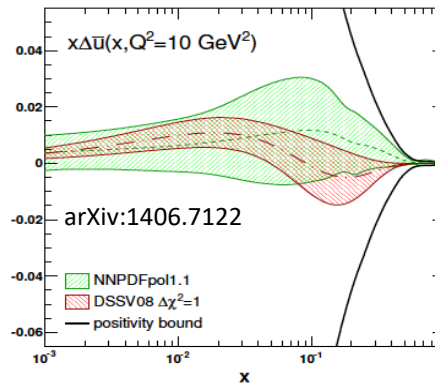
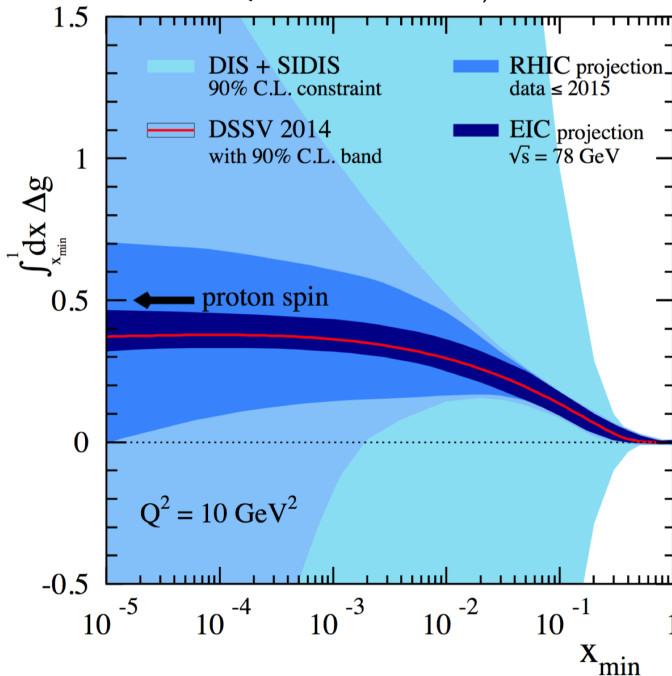

RECENT RESULTS FROM COMPASS

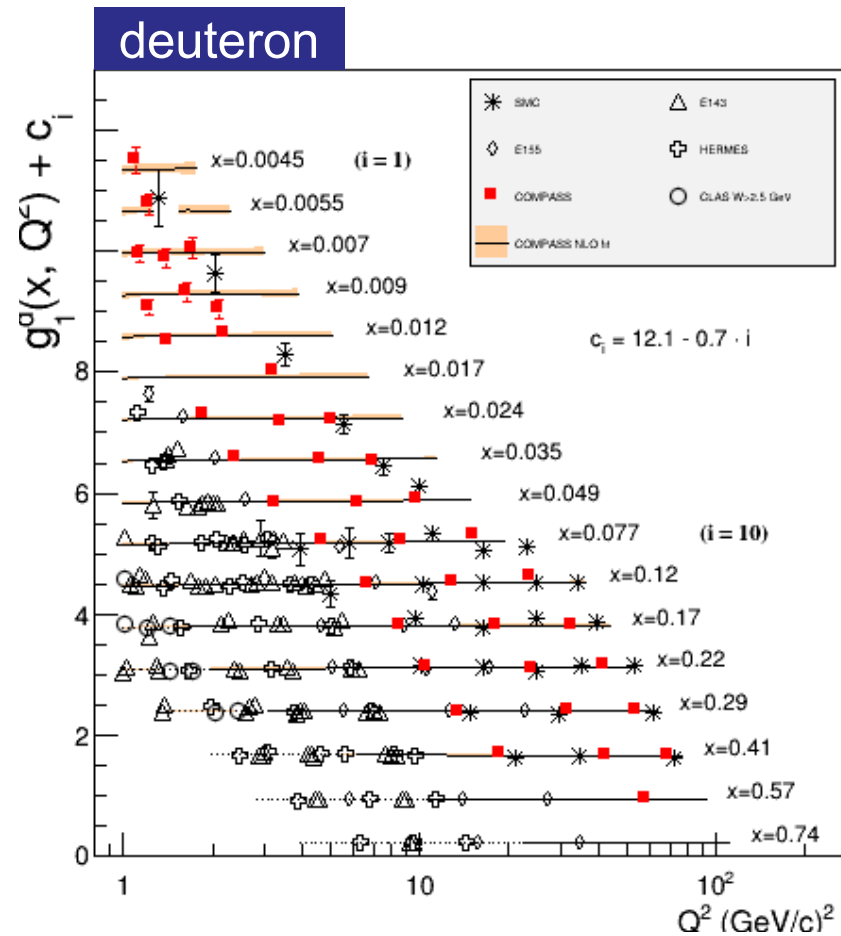
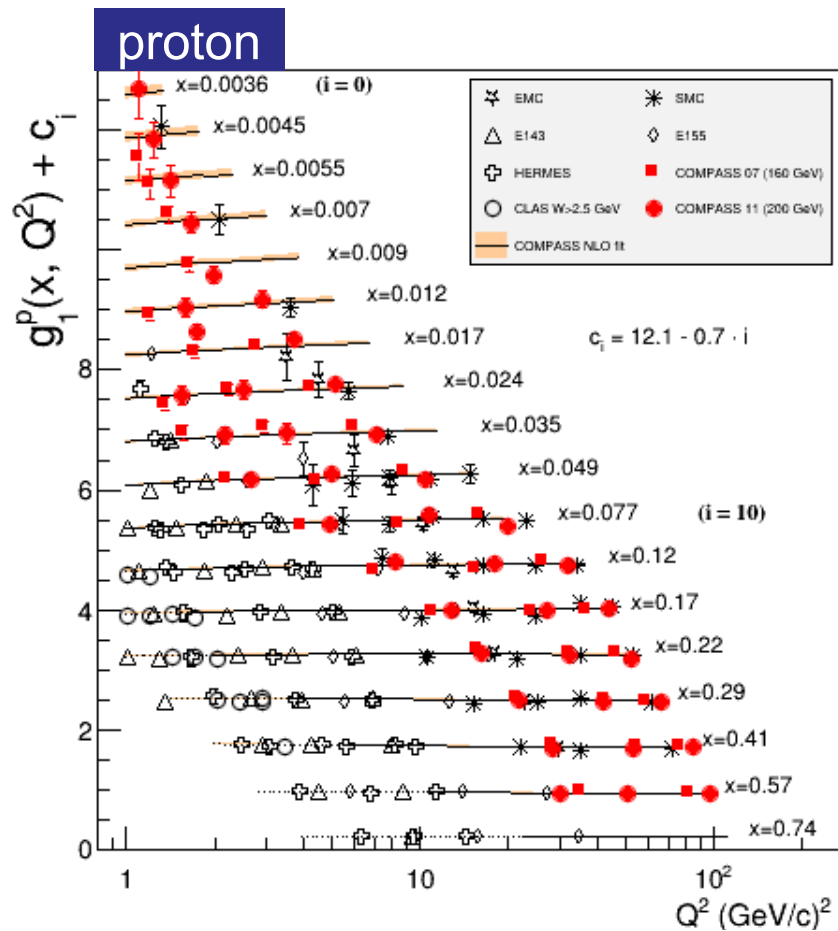

RECENT RESULTS FROM COMPASS

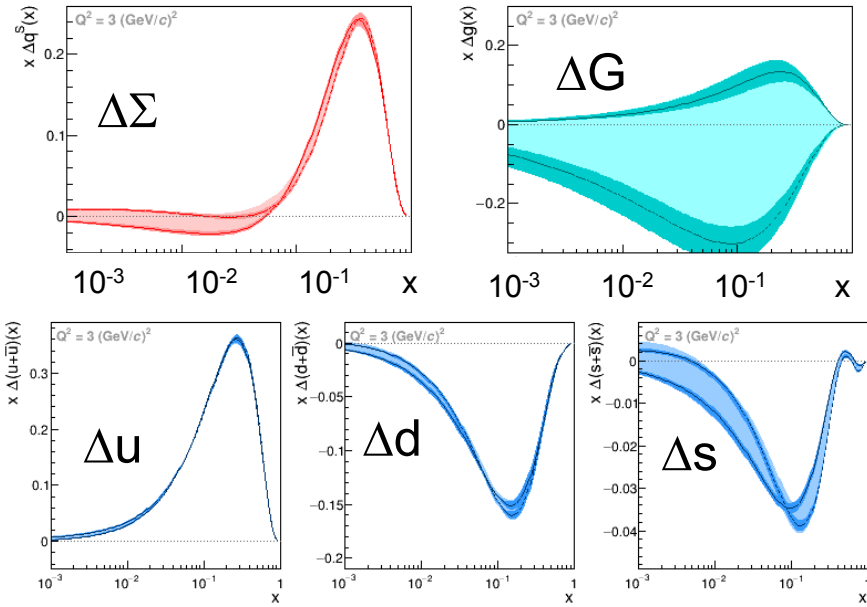

$$0.82 \leq \Delta U \leq 0.85 \quad -0.45 \leq \Delta D \leq -0.42 \quad -0.11 \leq \Delta S \leq -0.08$$

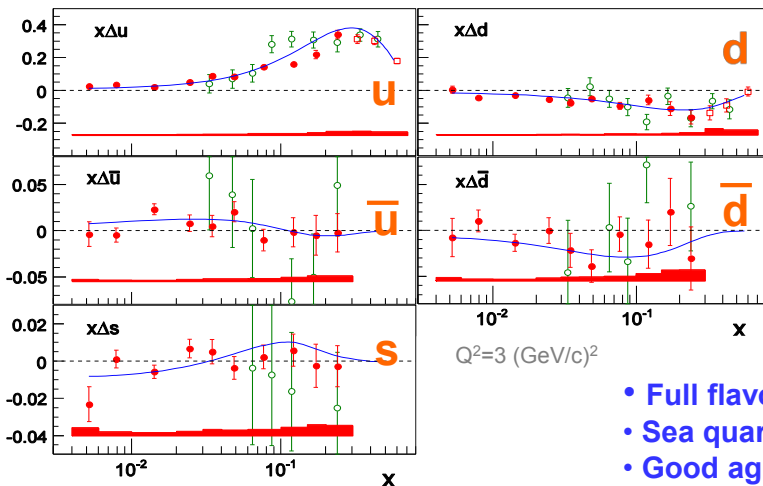

○ HERMES
 PRD71(2005)012003
● COMPASS
 PLB693(2010)227, using DSS-07 FFs
— DSSV at NLO

- Full flavour separation $\rightarrow x \sim 0.004$
- Sea quark distributions \sim zero
- Good agreement with global fits

WHAT'S MISSING?

- $\Delta u/u$ and $\Delta d/d$ at high x still poorly constrained
 - What is happening with the strange sea polarization? >0 ? $=0$? <0 ? Zero crossing? (Tension DIS – SIDIS)
 - Is the sea polarization isospin-symmetric? (note: we already know $\bar{u} \neq \bar{d}$)
 - Gluon helicity distribution at large x and a small x ? What is the integral ΔG ?
 - What happens at really small $x \ll 0.01$?
 - ... and where is the rest of the nucleon spin? (only 30-40% explained by quark helicities)
- ⇒ Orbital angular momentum of quarks, total angular momentum carried by gluons...

BEYOND THE 1-D PICTURE

What would we LIKE to observe?

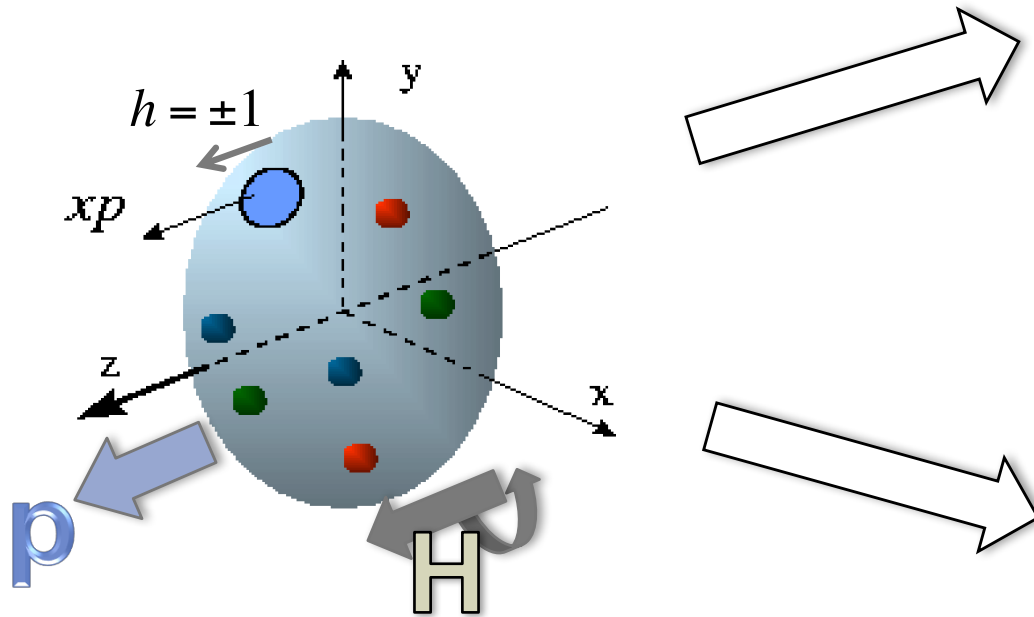

$$q(x, h \cdot H; Q^2)$$

Traditional “1-D” Parton Distributions (PDFs)
(inclusive, integrated over many variables)

3-D Picture of parton flavor, spin and momentum (TMDs)

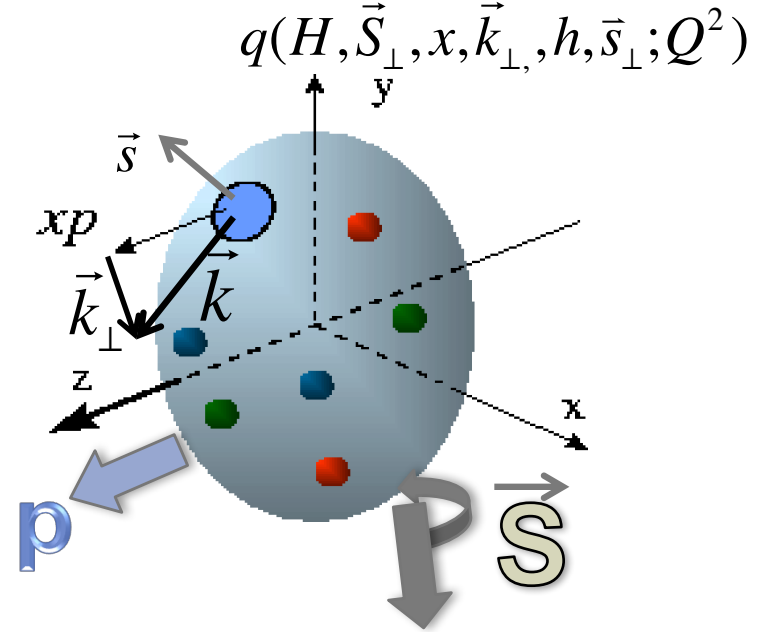

$$q(\vec{S}, x, \vec{r}_\perp, \vec{s}; Q^2)$$

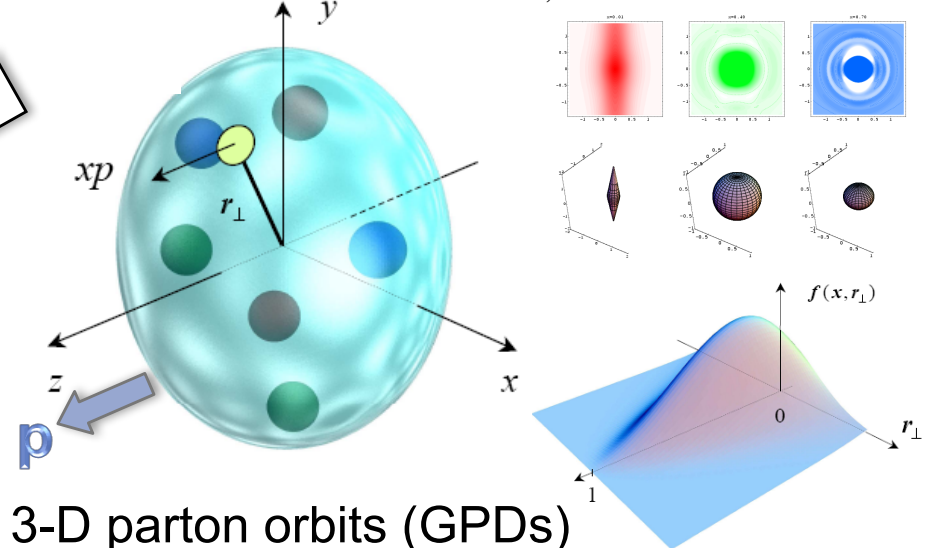

3-D parton orbits (GPDs)

BEYOND INCLUSIVE:

What CAN we observe?

Example: TMDs

- Have 2 pseudoscalars (h, H), 2 vectors (\hat{z}, \vec{k}_\perp) and 2 axial vectors ($\vec{S}_\perp, \vec{s}_\perp$)
- Observables depend on x (and Q^2) and must be scalars!
- 3 possibilities without \vec{k}_\perp :
 - 1 (ordinary PDFs \Rightarrow unpolarized structure function F_1)
 - Hh (helicity PDFs \Rightarrow spin structure function g_1)
 - $\vec{S}_\perp \cdot \vec{s}_\perp$ (transversity PDFs/structure function h_1)
- 4 possibilities linear in \vec{k}_\perp :
 - $H(\vec{k}_\perp \cdot \vec{s}_\perp), h(\vec{k}_\perp \cdot \vec{S}_\perp)$ (“Worm gear” PDFs g_{1T}, h_{1L}^\perp)
 - $\vec{S}_\perp \cdot (\vec{k}_\perp \times \hat{z}), \vec{s}_\perp \cdot (\vec{k}_\perp \times \hat{z})$ (Sivers, Boer-Mulders PDFs f_{1T}^\perp, h_1^\perp)
- Further possibilities quadratic in \vec{k}_\perp :
 - “Pretzelosity” $h_{1T}^\perp (\vec{k}_\perp \cdot \vec{S}_\perp) \cdot (\vec{k}_\perp \cdot \vec{s}_\perp) - \frac{1}{2} (\vec{S}_\perp \cdot \vec{s}_\perp) \vec{k}_\perp^2$
 - $(k_\perp)^2$ moments of the first three!

	1	h	s_\perp
1			
H			
S_\perp			

Preferably all sorted by quark flavor and for gluons, as well!

TOWARDS A COMPLETE PICTURE:

HOW can we access it?

Electroweak Probe to “see” partons...

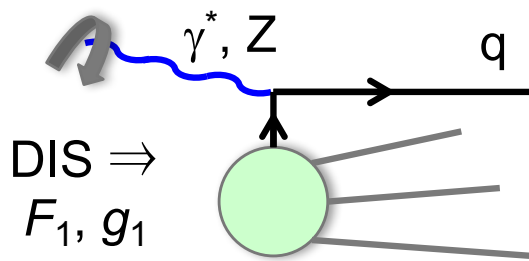

(1D only, no flavor tagging)

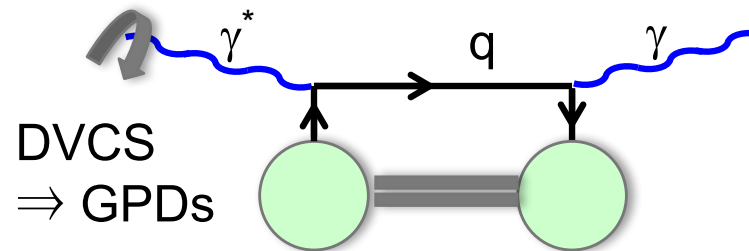

W production

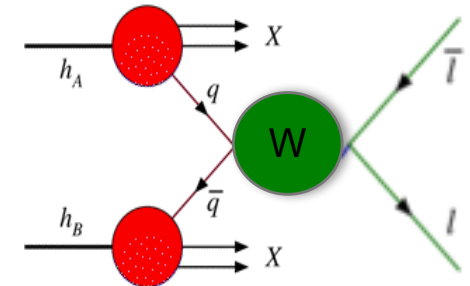

...+ extra hadrons to access all observables:

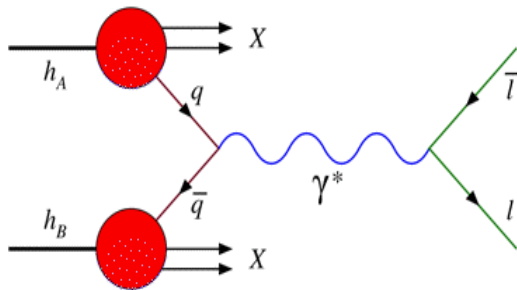

Drell-Yan

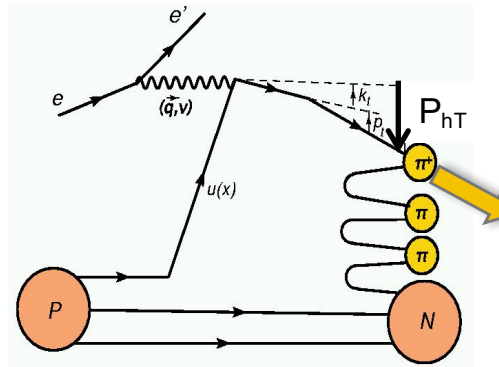

SIDIS

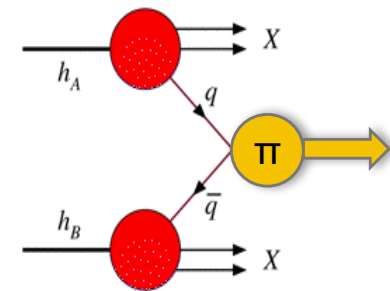

Hadron Production