

Running head: USING SCIENCE KITS TO CONSTRUCT CONTENT

Using Science Kits to Construct Content Understandings in Elementary Schools

Daniel Dickerson
Assistant Professor
Department of Educational Curriculum and Instruction
Old Dominion University
168-12 Education Building
Norfolk, VA 23529
757-683-4676
ddickers@odu.edu

Matthew Clark
Assistant Professor
Department of Middle & Secondary Education
Florida State University
209 Carothers Hall
Tallahassee, FL 32306
850-644-4977
mclark@coe.fsu.edu

Karen Dawkins
Director
Center for Science, Mathematics, and Technology Education
East Carolina University
319 South Cotanched St, Bldg 159
Greenville, NC 27858
252-328-6885
dawkinsk@mail.ecu.edu

Cathy Horne
Director of Science Content K-5
Wake County Public Schools
3600 Wake Forest Road
Raleigh, NC 27609
919-850-1600
CWHORNE@wcpss.net

Abstract

Although there is a considerable emphasis on inquiry-based, active learning in standards documents, curriculum documents, and textbooks, there exists a great deal of debate regarding the effectiveness of specific curricular and instructional approaches, including kit-based instruction. This study examines the efficacy of science kits in improving content knowledge. The method used involved treatment and comparisons groups composed of 2299 elementary school students in grades three, four, and five from ten different schools. In all the pairings but one, there were statistical differences in favor of the treatment groups or no statistical differences, suggesting that science kits enhance students' content understandings.

Introduction

Both the National Science Education Standards and the Benchmarks for Science Literacy echo the science education community's support for the notion of engaging all students in active, meaningful learning (National Research Council, 1996; American Association for the Advancement of Science, 1993). Such learning is often associated with hands-on instructional strategies and student-centered classroom environments. Many science teachers, however, fail to employ such research supported best practices and instead rely on more didactic, teacher-centered methods. The idea of changing teacher and student roles and altering learning environments by moving instruction away from more didactic, teacher-centered forms to more hands-on, student-centered forms historically served as one of the driving forces behind the use of science kits in formal education (Perisi, 1975; National Research Council, 2000). Over the past thirty years, however, many have questioned the effectiveness of kits in promoting and facilitating the type of active learning supported by reform-based documents (Saul & Reardon, 1996). Criticisms include the inappropriate implementation of kits such that instruction is rendered ineffective (Olguin, 1995; Saul & Reardon, 1996). Others, however, have argued the merits of using science kits on the grounds that they generate greater active participation among students, empower and engage populations that otherwise feel disenfranchised, promote positive classroom environments, increase teacher content knowledge, increase teacher confidence to teach science, and provide enjoyment for teachers who use them (Gennaro & Lawrenz, 1992; Ward, 1993; National Research Council, 2000; Monhardt, Spotted-Elk, Bigman, Valentine, & Dee, 2002; Houston, Fraser, & Ledbetter, 2003).

Research supporting the assertion that science kits increase teacher confidence in teaching science was of particular interest to us, because we are aware that one of the major concerns regarding the teaching of science in elementary schools involves low teacher confidence (Rice & Roychoudhury, 2003). Such concern is grounded in research reporting that many elementary teachers consider themselves to be uninformed concerning scientific content, making their development or choice of inquiry-based, hands-on science lessons an experience filled with apprehension (National Research Council, 2000). High anxiety coupled with no tangible external incentives to include science in their teaching and high-stakes testing demands in other content areas, creates an atmosphere where science instruction becomes expendable.

In response, many teachers, science education specialists, and administrators turn to science kits to address the issue of insufficient teacher content knowledge, lack of confidence, and concerns about frequency and quality of instruction (National Research Council, 2000). Determining the effectiveness of science kits to enhance student achievement provides these stakeholders with the ability to make more informed choices regarding their personal and collective investments in a given instructional approach. As such, the primary objective of this study was to examine the efficacy of the use of science kits in elementary contexts. In particular, we were interested in the relationship between an initiative to systemically implement kit-based instructional strategies within a large school district and student achievement regarding selected science concepts.

Methods

Participants included a total of 2299 elementary school students in grades three, four, and five from ten different schools within a large school district in the southeastern

United States. Teachers administered researcher-developed instruments (Appendix A, B, & C) to all students in their classes. The students in the ten participating schools completed the instruments during the same week.

Research Design

The five schools that constituted the treatment group had used science kits for as many as the past two years dependent upon the age of the school. Each grade level used different kits (e.g. Science, Technology, and Children (STC), Full Option Science System (FOSS), Teaching Relevant Activities for Concepts and Skills (TRACS), National Energy Education Development (NEED), and a school system-developed kit being piloted) based upon the learning objectives being addressed.

Selection and implementation of the kits was a decision made solely by the school district and conducted before the researchers began this study. As such, the comprehensive articulation of all rationales for the inclusion of specific kits remains unknown. Instead, the general rationale provided by the school district was that selections were made that conformed to content objectives in the mandated state curriculum and that were age appropriate according to vendor recommendation. Furthermore, because no single vendor provided kits for every objective in every grade, the school district assembled a committee comprised of administrators and science teachers who made selections from various vendors to organize a group of kits that, in combination, provided comprehensive coverage of curriculum content in each grade.

The committee's selections resulted in the use of four kits in each grade (i.e. 3rd, 4th, and 5th grades). A brief description of each kit and its basic contents is provided. In the third grade the following kits were used: (a) STC – Plant Growth and Development,

which contains plant seeds, fertilizers, containers, measuring devices, lighting, and a teacher's guide; (b) STC – Soils, which contains soils and sediments, containers, measuring devices, worms, and a teacher's guide; (c) TRACS – Investigating Objects in the Sky, which contains chalk, clay, measuring devices, models, and a teacher's guide; and (d) School system-developed physical science kit being piloted, which contains a Lego Dacta Kit, a selection of trade books, a set of plastic tools, and a teacher's guide. In the fourth grade, the following kits were used: (a) STC – Animal Studies, which contains aquarium and terrarium materials, frogs, crabs, plankton, vegetation, containers, measuring devices, and a teacher's guide; (b) FOSS – Earth Materials, which contains mineral specimens, evaporating dishes, containers, measuring devices, rock specimens, and a teacher's guide; (c) FOSS – Magnetism and Electricity, which contains batteries, bulbs, compasses, magnets, motors, iron filings switches, wire, and a teacher's guide; and (d) FOSS – Ideas and Inventions, which contains mirrors, pens, posters, containers, periscopes, textured objects, and a teacher's guide. Lastly, in the fifth grade, the following kits were used: (a) STC – Ecosystems, which contains aquarium and terrarium materials, fish, snails, algae, vegetation, soil, seeds, containers, measuring devices, and a teacher's guide; (b) TRACS – Investigating Weather Systems, which contains thermometers, barometers, containers, measuring devices, and a teacher's guide; (c) FOSS – Landforms, which contains sediments, maps, photos, containers, foam mountains, measuring devices, stream tables/trays, and a teacher's guide; and 4) NEED – Science of Energy, which contains glow sticks, hand warmers, chemicals, toys, solar panels, flashlights, thermometers, and a teacher's guide. All the kits used share common features: (1) they promote conceptual understanding; (2) they promote active learning

and exploration, (3) they provide background information for teachers, (4) they provide most lesson materials and supplies; (5) they include appropriate sequencing of science concepts, and (6) they have undergone extensive field testing by curriculum developers. There are some differences among the kits, however, including format, the number of enrichment activities, and the inclusion of interdisciplinary curricula.

The five schools selected as the comparison group were chosen based on a number of factors including: composite end-of-grade (EOG) scores on state standardized tests, percentage of free/reduced lunch, percentage non-white, student population of school, and school scheduling format (i.e. traditional vs. year-round enrollment). Selection of factors is based on research regarding comparison school equivalency (Campbell and Stanley, 1981; Grossman and Tierney, 1993; O'Sullivan, Fedora, Levine, MacKinnon-Tucker, McCullough, and Shaw, 2003). Each comparison school was selected to match an individual treatment school. None of the comparison schools used science kits as a regular, systematic part of science instruction. Although data were not available to provide frequencies of various instructional strategies used in comparison schools, analysis using thin description (i.e. "...a simple reporting of acts..."(Denzin, 2001, 162)) showed that typical modes of instruction included lecture, independent practice using worksheets, and textbook readings. Table 1 illustrates the pairings and also places the factors in order of significance (from left to right with left being the most significant) in the selection of paired schools.

[Insert Table 1 Here]

After we selected the comparison schools, classroom teachers administered an assessment instrument designed by the researchers containing eight items that focused on

science content objectives for each of the respective grades (Appendix A, B, & C). We selected a representative sample of science concepts addressed by both the state's standards and the science kits. We purposefully constructed the items to assess student conceptual understanding constructed from experiential learning. We completed face-validity tests for all instruments. Items were examined by two scientists, two science educators, two classroom teachers, and three students (one from each grade level). Refinements were made in response to suggestions. Tests for validity addressed issues including: 1) content addressed in each item conformed to the state science standards for the targeted grade level, 2) scientific content was accurate, 3) the items addressed rich and relevant content, 4) the distracters were appropriate, 5) the items discriminated between deep understanding and superficial familiarity, 6) the items addressed conceptual understanding, not memorized facts, 7) the items were appropriate for the grade levels addressed, including language, 8) the items were consistent with the content taught in the grade levels addressed, 9) the items were clear and understandable, and 10) the questions were not too easy or too hard. We scored the tests with a scanner, which provided totals for correct responses for each grade and school. All data were entered into SAS and statistical tests were run.

Data Analysis and Results

We tested for a significant difference between treatment and control sites by considering each pair of matched sites for a particular grade. Because of the variation in the number of participants and their performance across schools, we did not attempt to combine all treatment sites and all control sites for each grade; therefore, we have a separate analysis for all 15 pairs of the three grades across the five sites. After

determining that the data do not fit the traditional assumptions of normality, we chose the Wilcoxon rank-sum test for two independent samples for the analysis. Data analysis was conducted with the NPAR1WAY procedure in SAS software.

The Wilcoxon rank-sum test for each comparison tests the null hypothesis of no difference between the classes of that grade for the pair of matched schools. For this test, ranks were tabulated for test scores as if the two classes were combined. If the two classes had a sum of ranks from the combined sample that were similar, it was assumed that the two classes were not significantly different. However, if the sums were statistically different, the null hypothesis of no difference between the classes was rejected .

Table 2 shows the number of participants and the mean for all treatment and control sites for Grade 3. The p -value highlighted by an asterisk indicates a significant result in favor of the treatment group at the alpha level of .05.

[Insert Table 2 Here]

Table 3 shows the number of participants and the mean for all treatment and control sites for Grade 4. The p -values highlighted by an asterisk indicate a significant result in favor of the treatment group at the alpha level of .05, and the p -value highlighted by a double asterisk indicates a significant result in favor of the control group.

[Insert Table 3 Here]

Table 4 shows the number of participants and the mean for all treatment and control sites for Grade 5. The p -values highlighted by an asterisk indicate a significant result in favor of the treatment group at the alpha level of .05.

[Insert Table 4 Here]

Overall, the analysis showed a result in favor of the treatment group for 5 of the 15 pairs and in favor of the control group for only one pair.

Conclusions and Implications

In all the pairings but one, there were either no statistical differences in scores or else there were statistical differences in favor of the treatment groups. These results indicate that systemic implementation of science kits is successful in some contexts at enhancing student understanding as measured by application-based content questions. We acknowledge many variables exist such as frequency of kit use, implementation of kits, alternative approaches implemented in comparison schools, and teacher and student affective variables, all of which may serve to provide further insight into the effectiveness of the use of science kits in the classroom. However, we conducted this study within the limits of our resources (i.e. funding, time, and access to participants) and while additional lines of inquiry are necessary to gain a more complete picture of the efficacy of science kits, our findings contribute to the body of knowledge regarding science kit use by providing a comparison between structured systemic use and non-systematic teacher selected methods.

An important implication that stems from our findings involves keeping science kits available to stakeholders as an effective option for student learning. The literature includes many studies documenting the capacity of active science education (e.g. hands-on learning) as opposed to passive science education (e.g. copying notes from the board) to improve student attitudes towards science (National Research Council, 2000). It is reasonable to assume that the students participating in this study who engaged in active science education would also demonstrate more favorable attitudes towards science than

those involved in passive science education. Logically, if content knowledge test scores yielded by a passive and an active approach are about the same, the attitude advantage makes the active science education approach a better choice. The empirical results from this study suggest that in fourteen out of fifteen comparisons, there were improved content understandings and/or an inferred (Fraser, 1980; Freedman, 1997; Siegel & Ranney, 2003) attitude advantage among the treatment groups.

There is a related implication regarding the inferred attitude and confidence advantages with teachers since the use of science kits has been shown to enhance these areas (Rubino, Barley, & Jenness, 1994; National Research Council, 2000). If teachers exhibit greater confidence in their science teaching by using kits, it is logical to conclude that a systemic implementation of kits in a school district would make a difference for teachers who dislike science and/or lack confidence in teaching science. If teachers replace teacher-centered instructional strategies (e.g. textbook readings) with activities that actively engage children, there should be improvement in both student understanding of science and their attitudes toward science. Despite the challenges (e.g. logistics, teacher resistance) of implementing systemic science kit use within school systems, the properties of enhanced content knowledge and improved attitudes towards science make them a viable option for effective science teaching and learning.

References

- American Association for the Advancement of Science. (1993). *Benchmarks for science literacy*. New York: Oxford University Press.
- Campbell, D.T. & Stanley, J.C. (1981). *Experimental and quasi-experimental designs for research*. Boston, MA: Houghton Mifflin.

- Denzin, N.K. (2001). *Interpretive interactionism*. Thousand Oaks, CA: Sage Publications.
- Fraser, B.J. (1980). Science teacher characteristics and student attitudinal outcomes. *School Science and Mathematics, 80*, 300-308.
- Freedman, M.P. (1997). Relationship among laboratory instruction, attitude toward science, and achievement in science knowledge. *Journal of Research in Science Teaching, 34*, 343-357.
- Gennaro, E. & Lawrenz, F. (1992). The effectiveness of take-home science kits at the elementary level. *Journal of Research in Science Teaching, 29*(9), 985-994.
- Grossman, J. & Tierney, J.P. (1993). The fallibility of comparison groups. *Educational Review, 17*(5), 556-571.
- Houston, L.S., Fraser, B.J., & Ledbetter, C.E. (2003, April). *An evaluation of elementary school science kits in terms of classroom environment and student attitudes*. Paper presented at the meeting of the American Educational Research Association, Chicago, IL.
- Monhardt, R.M., Spotted-Elk, N., Bigman, D., Valentine, D., & Dee, H. (2002). It's about people: A successful school/university partnership. *Winds of Change, 17*(1), 14-17.
- National Research Council. (1996). *National science education standards*. Washington, DC: National Academy of Sciences.
- National Research Council. (2000). *Inquiry and the National Science Education Standards: A guide for teaching and learning*. Washington, DC: National Academy of Sciences.

- Olguin, S. (1995). Science kits as instruction tools. *On Common Ground*, 4, 8.
- O'Sullivan, R., Fedora, P., Levine, S., MacKinnon-Tucker, D., McCullough, A., & Shaw, T. (2003, March). *Comparison school equivalence: Reality or myth?* Paper presented at the annual meeting of the North Carolina Association for Research in Education, Holly Springs, NC.
- Perisi, C. (1975). Kindergarten science kits. *Instructor*, 84 (8), 62-63.
- Rice, D.C. & Roychoudhury, A. (2003). Preparing more confident preservice elementary science teachers: One elementary science methods teacher's self-study. *Journal of Science Teacher Education*, 14(2), 97-126.
- Rubino, A.N., Barley, Z.A., & Jenness, M. (1994). *Effects of science kit/in-service and kit use on teachers' science knowledge, attitudes, and teaching*. Western Michigan University Science and Mathematics Program Improvement (SAMPI). (ERIC Document Reproduction Service No. ED 382442)
- Saul, W. & Reardon, J. (Eds.) (1996). *Beyond the science kit: Inquiry in action*. Portsmouth, NH: Heinemann.
- Siegel, M.A. & Ranney, M.A. (2003). Developing the changes in attitude about the relevance of science (CARS) questionnaire and assessing two high school science classes. *Journal of Research in Science Teaching*, 40(8), 757-775.
- Ward, A. (1993). Magnets and electricity. *School Science Review*, 74(268), 31-38.

Table 1

Treatment and Comparison Pairings

School	Traditional/ Year-round	Composite Score from EOG	% Free/ Reduced Lunch	% Non-white	Student Population
Treatment 1	Traditional	78.8	29	59.8	435
Comparison 1	Traditional	78.7	32	45.7	381
Treatment 2	Traditional	74	35	48.2	278
Comparison 2	Traditional	73.1	34	32.8	485
Treatment 3	Traditional	84.6	25	49.7	616
Comparison 3	Traditional	86.1	24	36.5	902
Treatment 4	Traditional	88.4	29	36.2	387
Comparison 4	Traditional	88.5	21	31.3	719
Treatment 5	Year-round	96.7	7	33.9	982
Comparison 5	Year-round	95	4	19.1	964

Table 2

Pairwise Comparisons for Grade 3

	Treatment Site		Control Site		Test Statistic	P-Value
	N	Mean	N	Mean		
Pair 1	71	66.00	61	67.08	4092.00	.87
Pair 2	24	53.81	67	43.20	1291.50	.09
Pair 3	82	93.40	73	60.70	4431.00	<.001*
Pair 4	46	63.21	75	59.65	2907.50	.58
Pair 5	154	143.41	149	160.88	23971.50	.07

Table 3

Pairwise Comparisons for Grade 4

	Treatment Site		Control Site		Test Statistic	P-Value
	N	Mean	N	Mean		
Pair 1	42	48.89	43	37.24	2053.50	.03*
Pair 2	44	66.60	66	48.10	2930.50	<.01*
Pair 3	87	95.70	106	98.07	8326.00	.77
Pair 4	44	49.22	45	40.88	2165.50	.12
Pair 5	138	117.39	118	141.50	16696.50	<.01**

Table 4

Pairwise Comparisons for Grade 5

	Treatment Site		Control Site		Test Statistic	P-Value
	N	Mean	N	Mean		
Pair 1	49	51.74	40	36.74	1469.50	<.01*
Pair 2	24	48.58	69	46.45	1166.00	.73
Pair 3	100	106.87	80	70.04	5603.50	<.0001*
Pair 4	58	63.54	72	67.08	3685.50	.59
Pair 5	124	134.51	148	138.17	16679.50	.70

APPENDIX A

SCIENCE PROGRAM SURVEY 3rd GRADE

Instructions: With your teacher's help, fill in the circles to show your school code and grade level. For questions 1 through 10, darken the circle beside your choice for the best answer to the question.

School Code

0	<input type="radio"/>	<input type="radio"/>	<input type="radio"/>
1	<input type="radio"/>	<input type="radio"/>	<input type="radio"/>
2	<input type="radio"/>	<input type="radio"/>	<input type="radio"/>
3	<input type="radio"/>	<input type="radio"/>	<input type="radio"/>
4	<input type="radio"/>	<input type="radio"/>	<input type="radio"/>
5	<input type="radio"/>	<input type="radio"/>	<input type="radio"/>
6	<input type="radio"/>	<input type="radio"/>	<input type="radio"/>
7	<input type="radio"/>	<input type="radio"/>	<input type="radio"/>
8	<input type="radio"/>	<input type="radio"/>	<input type="radio"/>
9	<input type="radio"/>	<input type="radio"/>	<input type="radio"/>

Grade Level

3	<input type="radio"/>
4	<input type="radio"/>
5	<input type="radio"/>

- How do bees help flowers produce seeds?
 - They make honey to feed the plant.
 - They spread pollen from one flower part to another.
 - They flap their wings to keep the flower from getting overheated.
 - They clean the plant with their tongues.
- If you shine a flashlight at a mirror, what path does the light take?
 - Most of the light bounces back.
 - Most of the light passes through the mirror to the other side.
 - Most of the light goes into the mirror and stops.
 - Most of the light bends around the mirror.

- If you put clay, sand, and water in a test tube and shake the test tube up and then do not disturb the test tube anymore, what is likely to happen?
 - Within a minute, the sand and clay both settle to the bottom and the water is clear.
 - Within a minute, the sand settles to the bottom, but some of the clay stays mixed in with the water.
 - After three days, the clay settles to the bottom, but the sand stays mixed in with the water.
 - After three days, the sand, water, and clay stay all mixed up together.
- If you set up an experiment with the materials below, what might you be able to learn?
 - How heavy the soil is
 - The temperature of the soil
 - How well the soil holds water
 - The amount of soil

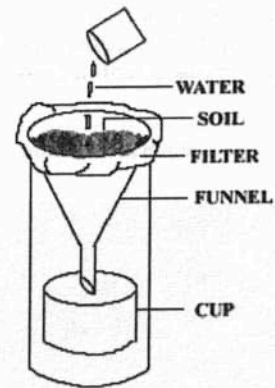

- How heavy the soil is
- The temperature of the soil
- How well the soil holds water
- The amount of soil

5. Which answer best describes the reading on the thermometer below?



- 24°F
 - 24°C
 - 85°F
 - 25°C
6. To show how much a plant grows in a certain amount of time, what would be a good label for the bottom of the graph below?

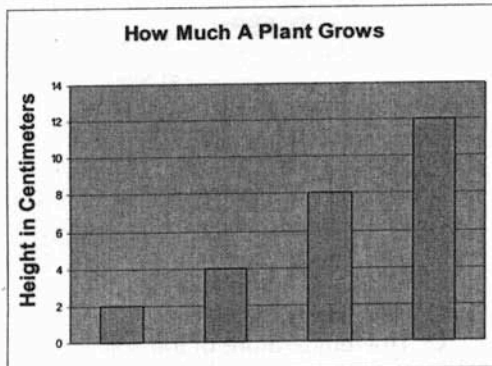

- Number of plants in a pot
- Amount of soil in a pot
- Number of days of growth
- Amount of water given each day

7. Which order of these moon phases best shows what happens as the moon changes?

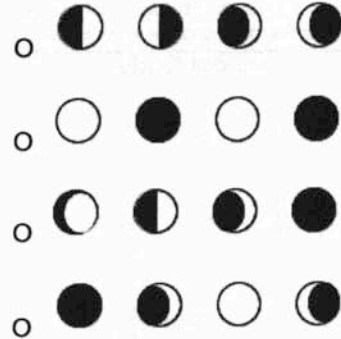

8. If you measured the shadow of a tree in your yard, at which time would the shadow be longest?
- Noon
 - Early afternoon
 - Mid afternoon
 - Late afternoon

APPENDIX B

SCIENCE PROGRAM SURVEY
4th GRADE

Instructions: With your teacher's help, fill in the circles to show your school code and grade level. For questions 1 through 10, darken the circle beside your choice for the best answer to the question.

School Code

0	<input type="radio"/>	<input type="radio"/>	<input type="radio"/>
1	<input type="radio"/>	<input type="radio"/>	<input type="radio"/>
2	<input type="radio"/>	<input type="radio"/>	<input type="radio"/>
3	<input type="radio"/>	<input type="radio"/>	<input type="radio"/>
4	<input type="radio"/>	<input type="radio"/>	<input type="radio"/>
5	<input type="radio"/>	<input type="radio"/>	<input type="radio"/>
6	<input type="radio"/>	<input type="radio"/>	<input type="radio"/>
7	<input type="radio"/>	<input type="radio"/>	<input type="radio"/>
8	<input type="radio"/>	<input type="radio"/>	<input type="radio"/>
9	<input type="radio"/>	<input type="radio"/>	<input type="radio"/>

Grade Level

3	<input type="radio"/>
4	<input type="radio"/>
5	<input type="radio"/>

- If you had a frog in a habitat in your classroom, what kind of behavior might you be able to observe?**
 - how rapid its heart beats
 - how it moves
 - how warm its water is
 - how large its tank is
- If you listed the parts of a frog's habitat, what would you include?**
 - length of body, number of legs, type of skin
 - size of eyes, location of ears, weight of body
 - type of food, amount of space, amount of water
 - how it breathes and how it swims

3. Which one of the electrical circuits below will make the light bulb glow?

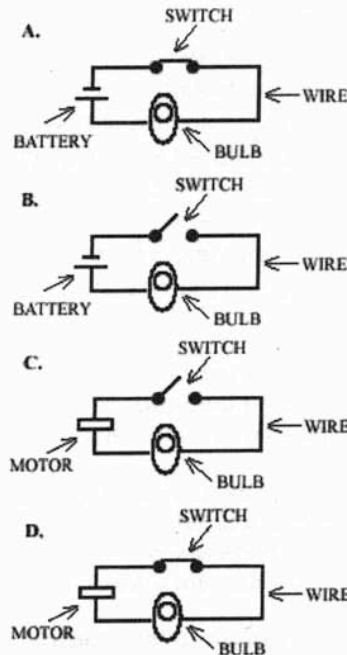

- A
- B
- C
- D

- What can you do to increase the strength of an electromagnet made with a nail, a battery, and metal wire?**
 - use a longer nail
 - insulate the wire with plastic
 - use a C battery instead of a D battery
 - wrap more turns of wire
- What is the difference between rocks and minerals?**
 - rocks are heavy; minerals are light
 - rocks will not dissolve in water; minerals will
 - rocks are made of different ingredients; minerals of only one
 - rocks are rough to touch; minerals are smooth

6. If you dissolve a mineral in a beaker of water, what is likely to happen if you leave the beaker in the sun for a few days?

- the water will evaporate, leaving the mineral behind
- the water and mineral will both evaporate, leaving an empty beaker
- the water will remain, but the mineral will disappear
- the water and the mineral will both remain in the beaker

7. Which of these statements is ALWAYS true about inventions?

- inventions always start with an idea
- inventions always help you do something faster or better
- inventions always turn into an idea
- inventions are always useful

8. If you wanted to lift a heavy rock with a metal bar, which arrangement below will make it easiest for you?

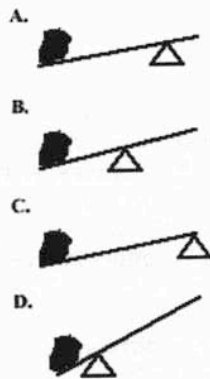

- A
- B
- C
- D

APPENDIX C

SCIENCE PROGRAM SURVEY 5th GRADE

Instructions: With your teacher's help, fill in the circles to show your school code and grade level. For questions 1 through 10, darken the circle beside your choice for the best answer to the question.

School Code

0	<input type="radio"/>	<input type="radio"/>	<input type="radio"/>
1	<input type="radio"/>	<input type="radio"/>	<input type="radio"/>
2	<input type="radio"/>	<input type="radio"/>	<input type="radio"/>
3	<input type="radio"/>	<input type="radio"/>	<input type="radio"/>
4	<input type="radio"/>	<input type="radio"/>	<input type="radio"/>
5	<input type="radio"/>	<input type="radio"/>	<input type="radio"/>
6	<input type="radio"/>	<input type="radio"/>	<input type="radio"/>
7	<input type="radio"/>	<input type="radio"/>	<input type="radio"/>
8	<input type="radio"/>	<input type="radio"/>	<input type="radio"/>
9	<input type="radio"/>	<input type="radio"/>	<input type="radio"/>

Grade Level

3	<input type="radio"/>
4	<input type="radio"/>
5	<input type="radio"/>

1. Which of the following sources of energy is considered nonrenewable?
- hydropower
 - petroleum
 - solar
 - wind

2. Which of the statements below is true regarding energy transformations?
- chemical energy is converted to mechanical (motion) energy when your body uses food
 - radiant energy is converted to mechanical (motion) energy when a motor turns an airplane propeller
 - potential energy is converted to kinetic energy when electrical energy is used to heat an oven
 - mechanical (motion) energy is converted to potential energy when windmills produce electricity

3. Refer to the topographic map below and choose the point of highest elevation.

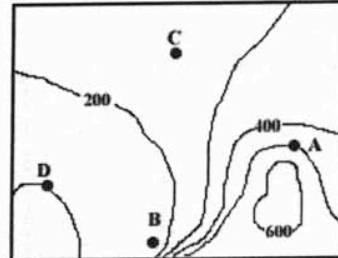

- A
- B
- C
- D

4. If you conducted a stream table experiment, which of these actions would you predict to increase the amount of erosion and deposition?
- use more water
 - use less water
 - make the slope flatter
 - place a barrier in the water path
5. What is the source of energy that drives weather systems?
- wind
 - water
 - sun
 - rain

6. In the diagram representing the water cycle below, what process is represented by the arrow marked "X"?

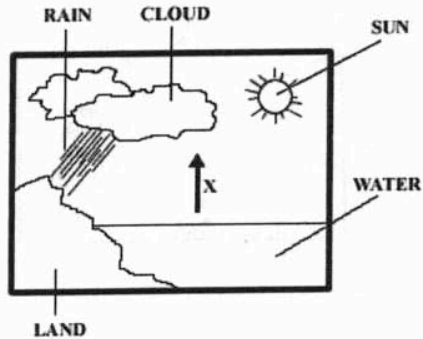

- evaporation
 - precipitation
 - condensation
 - elevation
7. If you construct an aquarium with snails, fish, algae, and a water plant, what kind of relationship exists in your ecosystem?
- the fish provide food for the water plant; the water plant provides carbon dioxide for the fish
 - the fish provide oxygen for the water plant; the water plant provides shelter for the fish
 - the snails provide carbon dioxide for the algae; the algae provide food and oxygen for the snails
 - the snails provide food for the fish; the fish provide oxygen for the snails

8. What would likely happen to your aquarium if all the plants and algae died?
- the snails would live, but the fish would die
 - the fish would live, but the snails would die
 - both the fish and the snails would live
 - both the fish and the snails would die